

LIGHT EMITTING DIODES 1.6÷4.6 μm

Model LED21-PR 2.15 mm 1.1 mW

•Light Emitting Diodes **LED21-PR** are designed for emitting at a spectral range around 2150 nm. Heterostructures (HS) are grown on GaSb substrates. The output emission can be modulated by current flowing in a forward direction.

•Light Emitting Diodes **LED21-PR** are developed for using in optical gas sensors and medical diagnostics. They have stable output power and lifetime more then 10000 hours.

•Related products: **LED21-PR** can be used in optical pair with our photodiodes **PD24**. Our standard **LED Driver** provides power supply of **LED21-PR** in two recommended here regimes (Quasi-CW and Pulsed).

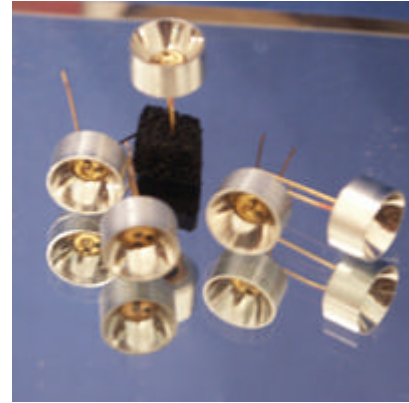

Parameters	Min	Typ	Max
Wavelength, μm	2.10	2.15	2.19
FWHM, μm	0.15	0.20	0.25
Optical Power, mW			
Quasi-CW @ 200 mA	0.9	1.1	1.3
Pulsed@1A	25	28	30
Switching Time, ns	10	30	50
Operating Temperature Range, °C	-240÷+50		
Emitting Area, μm	300x300		
Soldering temperature	260 °C		
Package	TO-18 with Parabolic Reflector		

Recommended regimes of operation

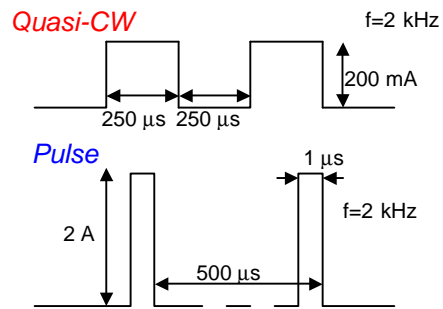

Package TO-18 with Reflector

