

PD24-05-PR Mid-Infrared Photodiodes

Description

Photodiodes PD24-05-PR are fabricated from narrow band-gap GaInAsSb/AlGaAsSb-based heterostructures lattice matched to GaSb substrate, and are designed for detection of light signals in Mid-Infrared spectral range with cut-off wavelength around 2.45 μm .

Features

- Diameter of photosensitive area: 0.5 mm
- Fast Response: <50 ns
- Package: TO-18 with a parabolic reflector without a window

Applications

- Industrial Process Control
- Sensor development
- Medical diagnostics

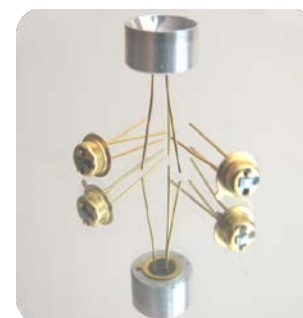

Specification

Recommended modes of PD operation

We recommend using photovoltaic mode, when PD is used under no reverse bias.

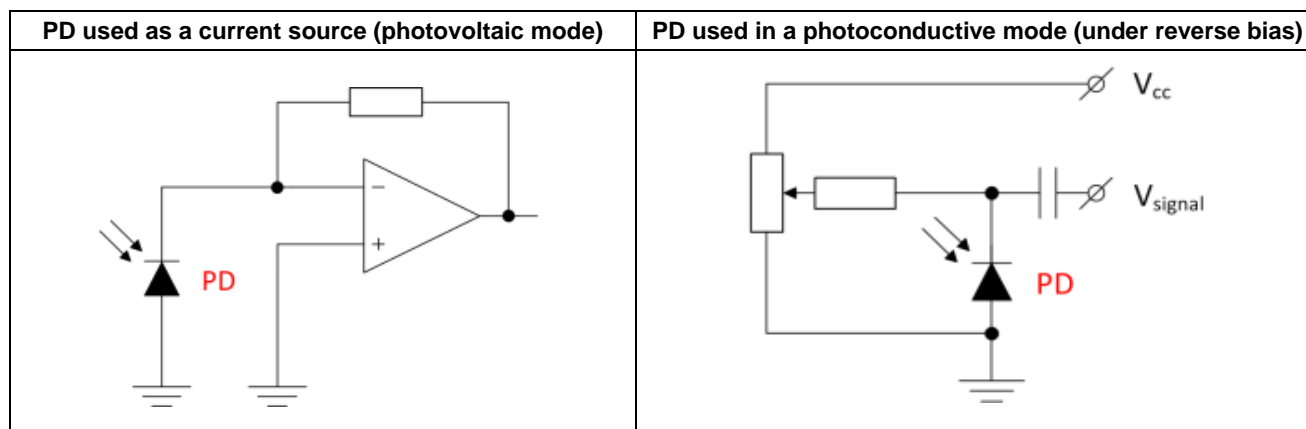

Device Parameters

Device Parameters	Symbol	Value	Units
Sensitive area diameter	d	0.5	mm
Storage temperature	T_{stg}	-200 ~ +70	$^{\circ}\text{C}$
Operating temperature	T_{opr}	-200 ~ +60	$^{\circ}\text{C}$
Reverse voltage	V_r	-1	V

Optical and Electrical Characteristics

Photodiode Parameters	Conditions	Symbol	Value	Units
Cut-off wavelength	T=300 K	λ_{cut}	2.45	μm
Max. sensitivity wavelength (>90%)	T=300 K	λ_p	1.4 — 2.2	μm
Dark current	T=300 K, $V_r=-1$ V	I_d	40— 100	μA
Shunt resistance	T=300 K, $V_r=-10$ mV	R_{sh}	4 — 10	k Ω
Capacitance	T=300 K, $\lambda=\lambda_p$	C	200 — 400	pF
Sensitivity	T=300 K, $\lambda=\lambda_p$	S	0.7-1.1	A/W
Detectivity	T=300 K, $\lambda=\lambda_p$	D^*	(2-5) $\cdot 10^{10}$	$\text{cm}\cdot\text{Hz}^{1/2}\cdot\text{W}^{-1}$

Typical Characteristic Curves

Spectral response (typical)

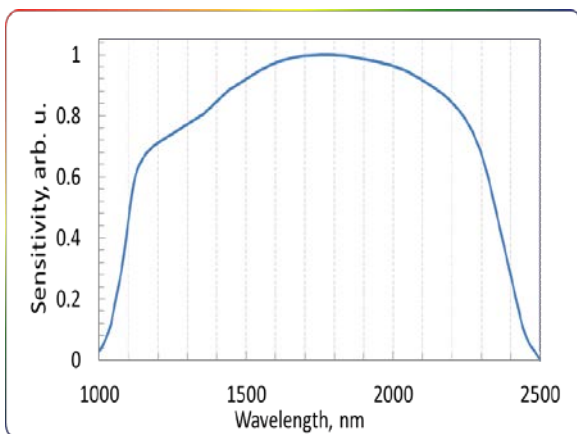

Temperature shift of spectral response

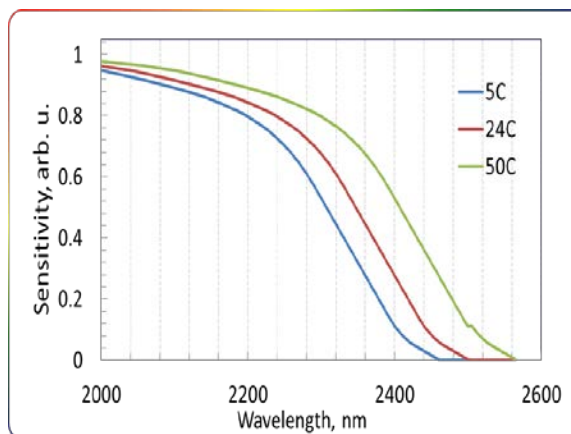

Dark current temperature dependence

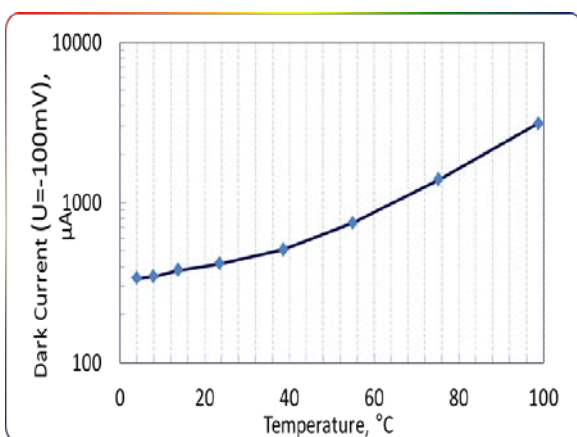

Resistance-temperature dependence

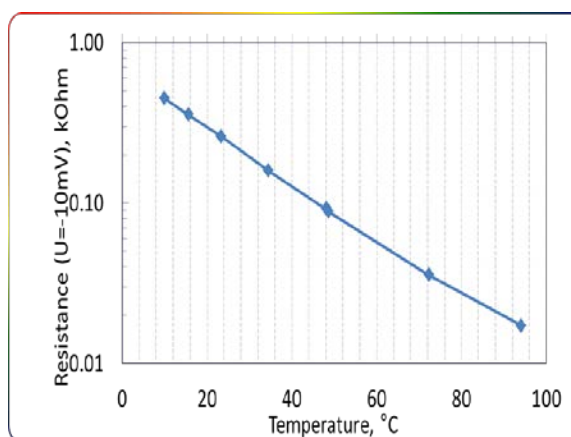

TO18 Package with a parabolic reflector without a window

Dimension Drawing (units: mm)

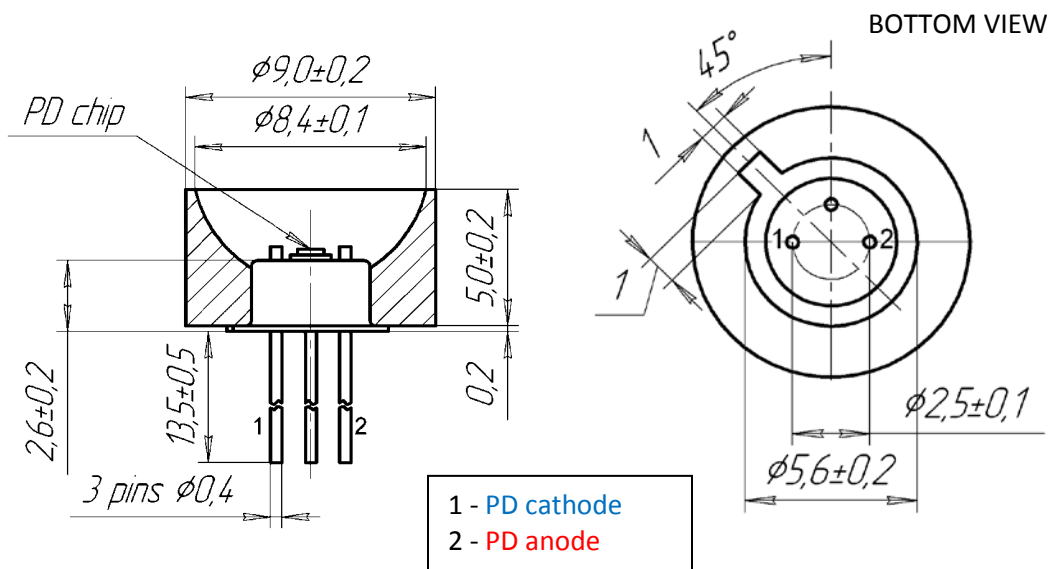

Precautions

Photodiodes are polarity sensitive. Please note the anode of PD is marked with a RED dot. Check all polarity connections before using the device. Please do not connect the PD to the multimeter.

The MID-IR photodiodes are ESD (electro static discharge) sensitive and should be handled with the proper ESD protection environment.