



Device parameters	Symbol	Value	Units
Storage temperature	$T_{\text{stg}}$	-25...+50	$^{\circ}\text{C}$
Operating temperature	$T_{\text{opr}}$	-25...+50	$^{\circ}\text{C}$
Lead soldering temperature (time < 3 seconds, 3 mm from case)	$T_{\text{sol}}$	+180	$^{\circ}\text{C}$

LED parameters	Conditions	Symbol	Value	Units	
Peak emission wavelength	$T = 25^{\circ}\text{C}$ , $I = 150\text{ mA qCW}$	$\lambda_p$	3.30 - 3.55	$\mu\text{m}$	
FWHM of the emission band	$T = 25^{\circ}\text{C}$ , $I = 150\text{ mA qCW}$	FWHM	250 - 600	nm	
Output optical power	quasi-CW mode	$I = 200\text{ mA}$ , duty cycle 50%	$P_{\text{qcw}}$	min 80	$\mu\text{W}$
	pulse mode	$I = 1\text{ A}$ , $f = 2\text{ kHz}$ , duty cycle 0.1%	$P_{\text{pulse}}$	min 950	$\mu\text{W}$
Forward Voltage	$T = 25^{\circ}\text{C}$ ; $I = 200\text{ mA qCW}$	V	0.2 - 0.5	V	

#### Maximum allowable operation current

Mode	Frequency	Duty cycle	Pulse duration	Maximum current
quasi- CW	0.5 kHz	50%	1000 $\mu\text{s}$	250 mA
pulse	2 kHz	0.1%	0.5 $\mu\text{s}$	1 A

Light-Emitting Diodes Lms34LED series are fabricated from narrow band-gap InAsSbP/InAs-based heterostructures lattice matched to InAs substrate.

Spectra at 200 mA (qCW, duty cycle 50%,  $T=25^{\circ}\text{C}$ )

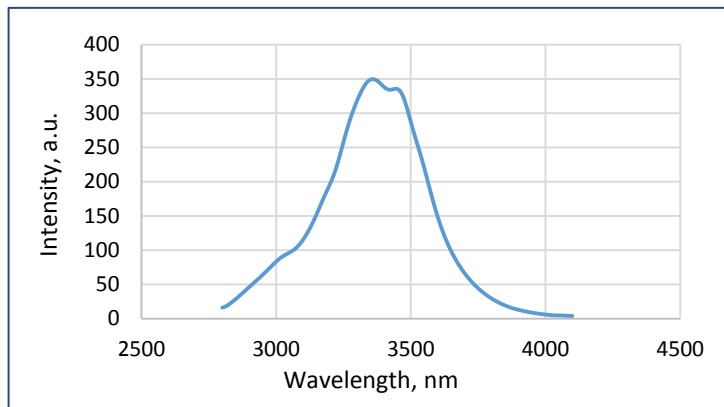

LED Typical Power Characteristic (qCW,  $T=25^{\circ}\text{C}$ )

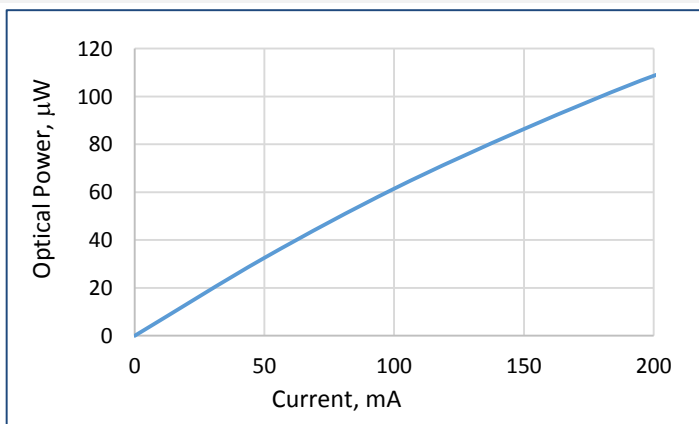

LED Typical Current-Voltage Characteristic (qCW,  $T=25^{\circ}\text{C}$ )

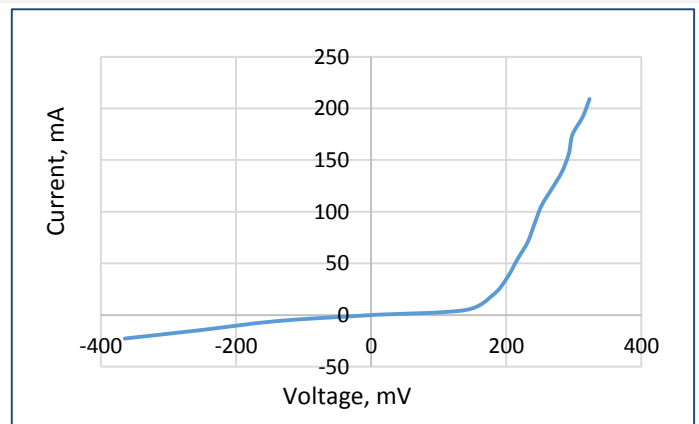

Packages	Model
TO-18 with a glass cover	Lms MIR LED-CG

To drive the LED we recommend using:

- LED basic circuit connection

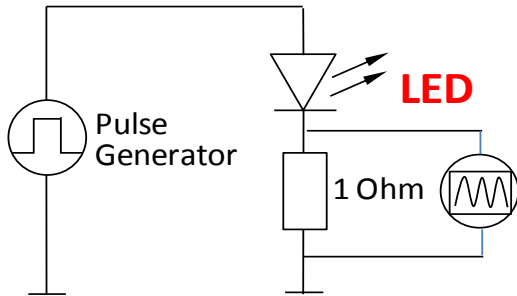

- LED drivers and evaluation boards designed by LED Microsensor NT

We recommend to use **Quasi Continuous Wave (qCW) mode** with duty cycle 50% or 25% to obtain maximum average optical power and short **Pulse modes** to obtain maximum peak power. Hard CW (continius wave) mode is NOT recommended.

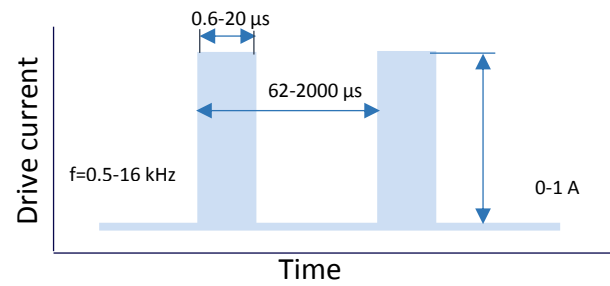
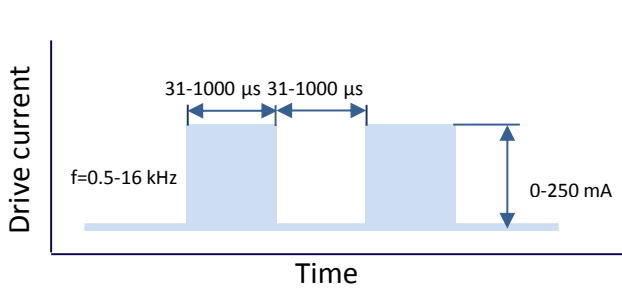

### IMPORTANT CAUTIONS:

- check your connection circuit before turning on the LED;
- mind the LED polarity: LED anode is marked with a RED dot;
- do not connect the LED to the multimeter;
- do not touch the glass covering and do not apply any force to it;
- observe the allowable operating temperature range, exceeding this eange may cause irreparable damage of the glass cover

Technical Drawing

Lms MIR LED-CG

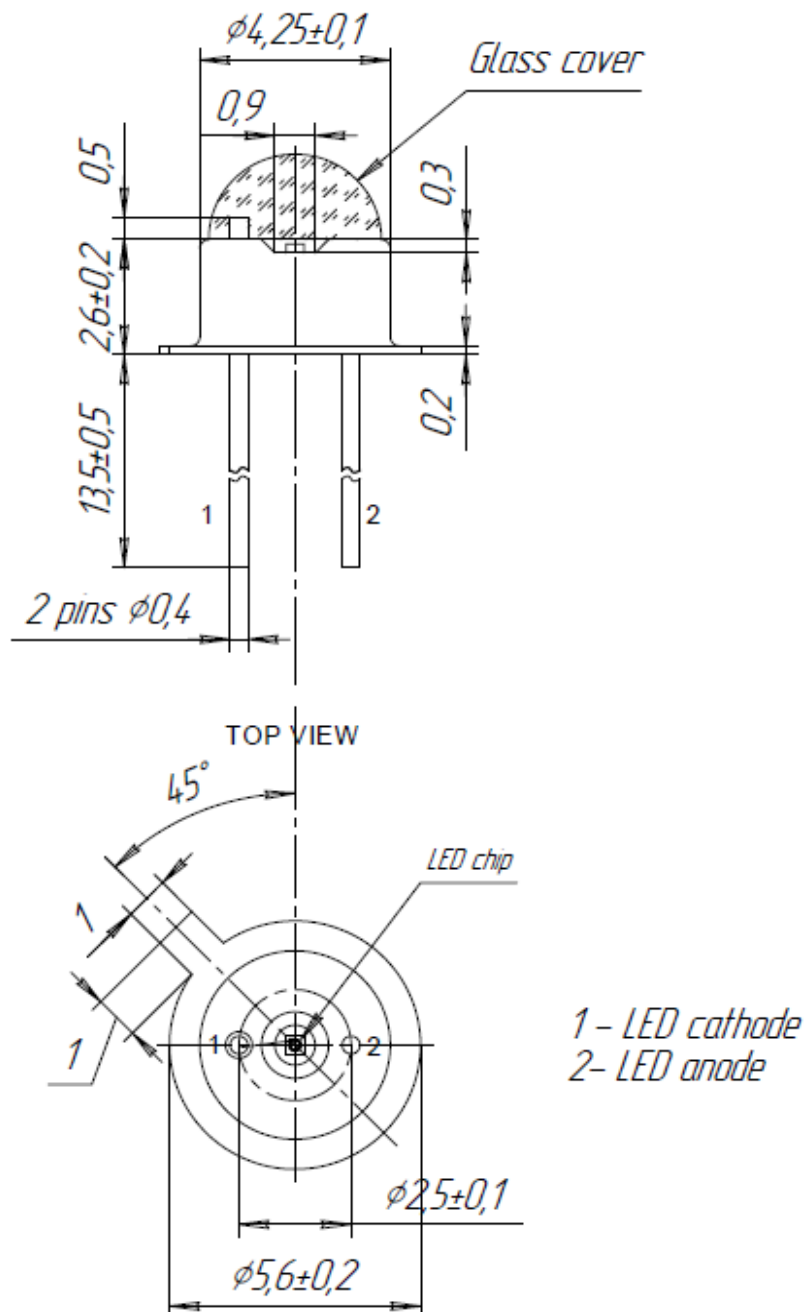

Related Products

- **Photodiodes (Lms36PD-XX series)** - spectrally matched detectors of mid-infrared radiation
- **D-41/D-51 LED drivers** - devices for LED driving with adjustable parameters
- **mD-1p/mD-1c minidrivers** - devices for LED driving with fixed parameters