

# LED23FC-TEC-PR Mid-Infrared Light Emitting Diode

## Description

The LED23FC-TEC-PR module is a light emitting diode designed with narrow band gap GaInAsSb/AlGaAsSb based heterostructures and manufactured with Metal-Organic Chemical Vapor Deposition (MOCVD) and liquid-phase epitaxy (LPE) technologies, with flip-chip packaging. It emits infrared (IR) radiation with center wavelength at 2350 nm.

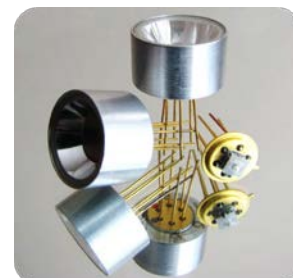

## Features

- Flip-chip packaging with larger chip size
- Fast Response: <50 ns
- High Modulation: 100 MHz
- Package: TO-5 with a built-in thermocooler and thermoresistor, covered by a parabolic reflector with a glass window

## Applications

- Industrial Process Control
- Sensor development
- Medical diagnostics

## Specification

### Operation Mode

IR LED can be operated in Quasi Continuous Wave (qCW) mode or Pulse mode. qCW mode with duty cycle 50% or 25% is recommended to obtain maximum average optical power while short Pulse mode is recommended to obtain maximum peak power. Hard CW (continuous wave) mode is NOT recommended.

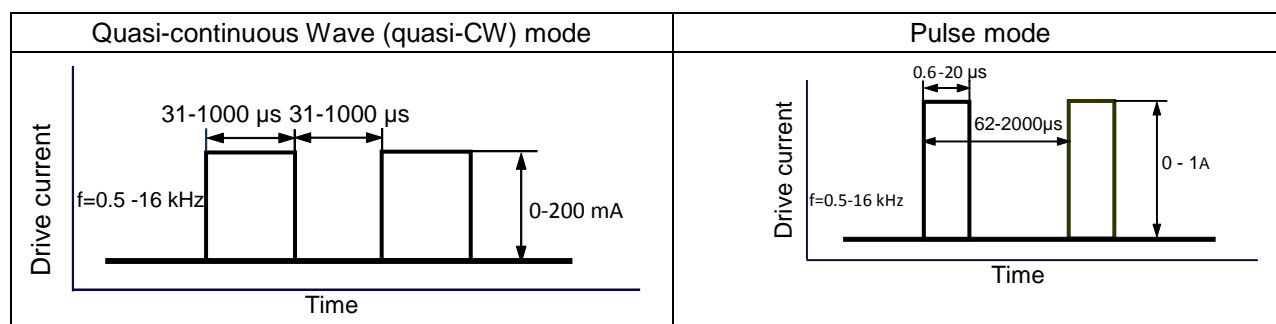

### Optical and Electrical Characteristics

| LED23FC-TEC-PR – Flip-chip LED |       |                                 |         |      |      |
|--------------------------------|-------|---------------------------------|---------|------|------|
| Parameters                     | Units | Conditions                      | Ratings |      |      |
|                                |       |                                 | Min     | Typ  | Max  |
| Peak emission wavelength       | μm    | T=300 K, I = 150 mA qCW         | 2.30    | 2.35 | 2.37 |
| FWHM of the emission band      | nm    | I = 150 mA qCW                  | 200     | 270  | 340  |
| Quasi-CW Optical Power         | mW    | I = 200 mA qCW                  | 0.8     | 1.0  | 1.4  |
| Pulsed Peak Optical Power      | mW    | I=1 A, f=1 kHz, duty cycle 0.1% | 20      | 25   | 30   |
| Voltage                        | V     | T=300 K, I=200 mA               | 1.2     | -    | 2.8  |
| Switching time                 | ns    | T=300 K                         | 10      | 20   | 30   |
| Operating temperature range    | °C    | -200 ~ +50                      |         |      |      |
| Soldering temperature          | °C    | 180                             |         |      |      |

### Typical Characteristic Curves

Spectra at different currents (qCW, T=300 K)

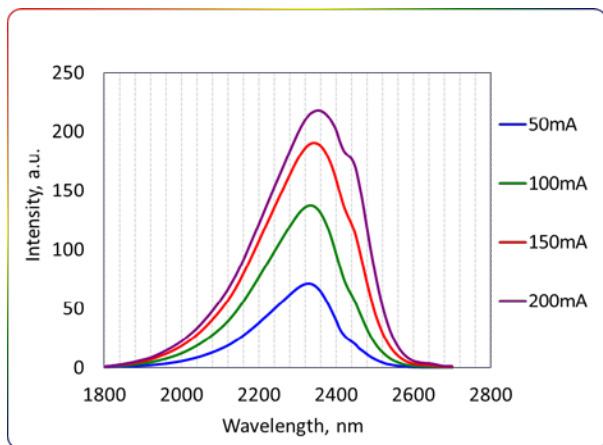

Spectra at different temperatures (qCW, I=150 mA)

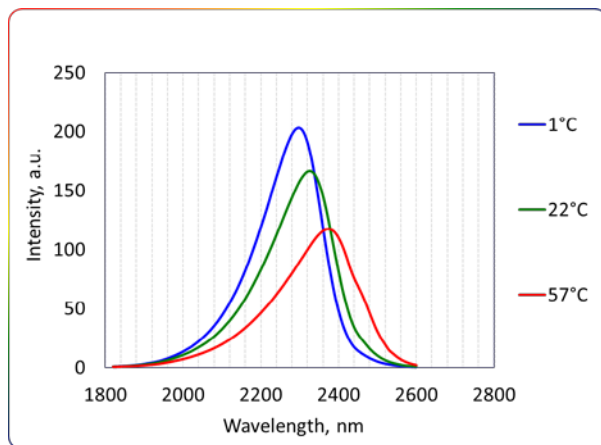

LED Power Characteristic (quasi-CW mode, T=300K)

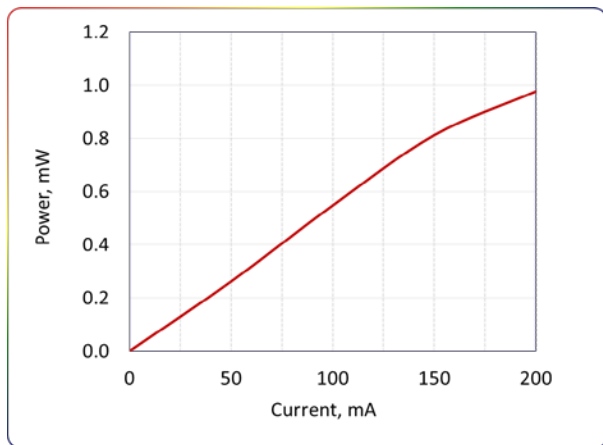

LED Typical Current-Voltage Characteristics (T=300K)

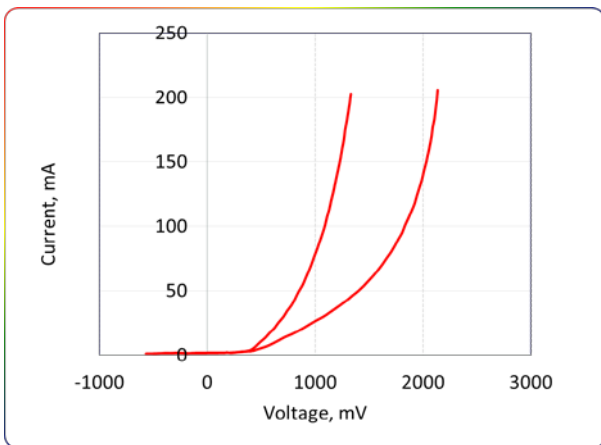

Beam Divergence (Far-field pattern)

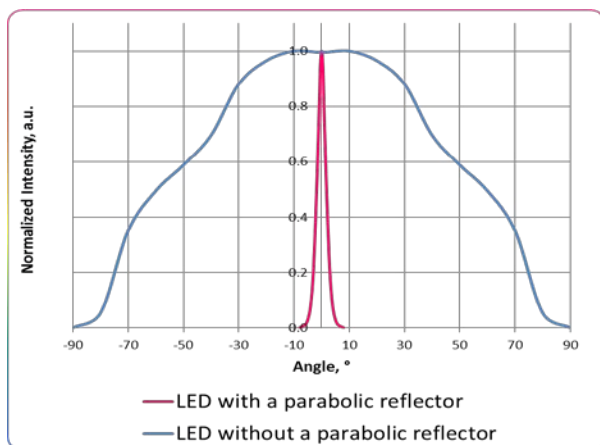

### Note

**LED polarity Mark**  
LED anode is marked with a **RED** dot.

## TO-5 Package with a Built-in Thermoelectric Cooler (TEC) and Thermistor, Covered by a Parabolic Reflector with a Glass Window

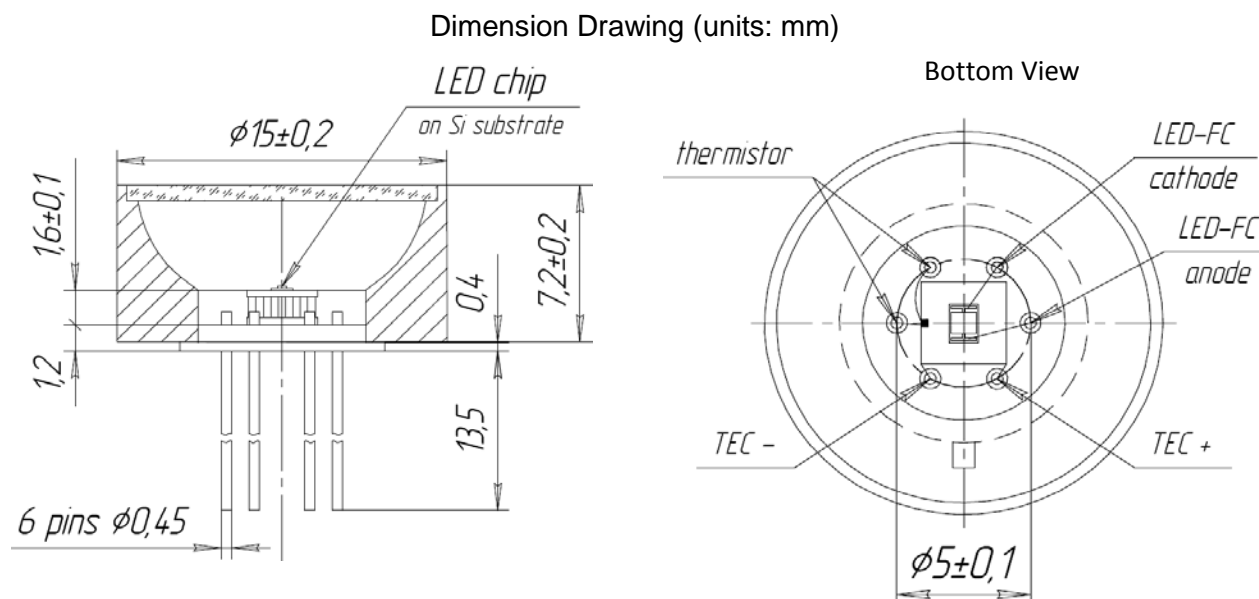

### Driver for LED with thermoelectric module

Basic Driver Circuit Reference Design for LED with thermoelectric module

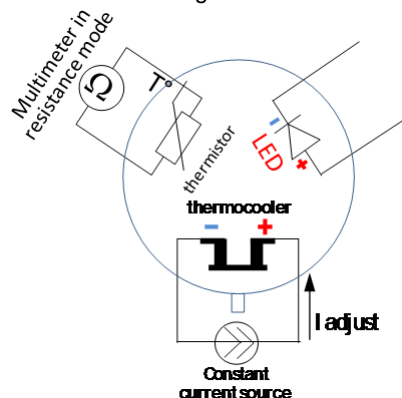

Available LED Drivers

Model number

- DLT-27
- DLT-37
- D41 (coming soon)
- D51 (coming soon)

Refer to corresponding sections on the catalog for more information.

### Precautions

LEDs are polarity sensitive. Please note the anode of LED is marked with a RED dot. Check all polarity connections before using the device. Please do not connect LED to multimeter.

The IR light emitting diode products are Electro Static Discharge (ESD) sensitive and should be handled with the proper ESD protection environment and personnel training. The ESD related damage of the device is not covered under warranty. In order to ensure the proper functioning of LED care must be given to maintain the highest standards of compliance to the maximum electrical specifications when handling such devices. The LEDs are particularly sensitive to any voltage that exceeds the absolute maximum ratings of the product. Any applied voltage in excess of the maximum specification will cause damage and possible failure to the product. The user must use handling procedures that prevent any electro static discharges or other voltage surges when handling or using these devices.